

FURUNO[®]

Revolutionary heading sensor

SATELLITE COMPASS

Model SC-110



The future today with FURUNO's electronics technology.

FURUNO ELECTRIC CO., LTD.

2-52-1 Ashikaga-cho, Nishikujo City, Japan Phone: +81 (0)300 85 3144

Catalogue No. N-858

TRADE MARK REGISTERED

Furuno's high-grade satellite compass provides superior heading accuracy for AIS, ECDIS, Radar and more



Compass Rose Mode

- Provides highly accurate heading data for autopilot, radar, AIS, Sonar and plotting systems
- IMO MSC.116(73) type approved as a verified THD (Transmitting Heading Device) with high accurate $\pm 0.6^\circ$
- Rapid $45^\circ/s$ follow-up rate greatly exceeds IMO High Speed Craft requirements $20^\circ/s$
- High accurate GPS, WAAS Data – SOG, COG, ROT, and L/L
- High Contrast 4.5" Silver Bright LCD
- Precision Pitch/Roll Data in Analog and Digital formats for vessel stabilizers, sonar, etc.
- Multiple High Speed Heading Data Output in IEC 61162-1/2 (NMEA0183/HS)
- 100% free of yearly or regular maintenance – No Recurring Costs
- Unique Tri-Antenna System improves system accuracy and reduces the effects of yaw, pitch and roll

Principle

With the SC-110, a ship's heading is determined by decoding the phase data in the GPS carrier frequency. In principle, a pair of antennas A1(ref) and A2(foe), each connected with an associated GPS engine and processor, are installed along the ship's fore-aft line. The GPS systems at A1 and A2 calculate the range and azimuth to the satellite.

The difference in range between A1 and A2 is $\Delta\lambda + n\lambda$ where λ is 19 cm and n^* is automatically found during the initialization stage. A fraction of a carrier wavelength, $\Delta\lambda$, is processed by Furuno's advanced kinematic technology in geographical survey, thus determining a vector (range and orientation) A1 to A2, i.e., heading of ship relative to north.

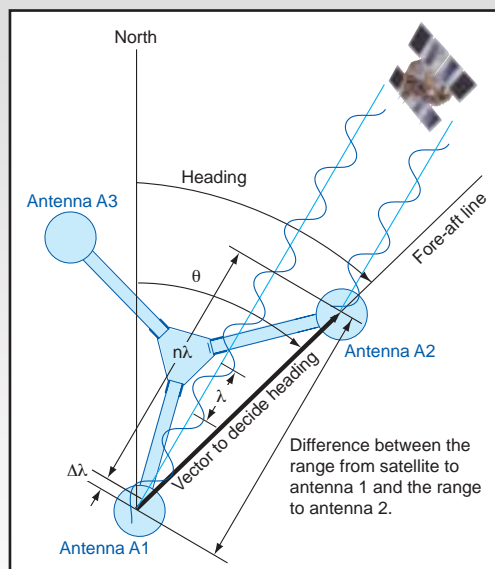

In reality, a third antenna is added to reduce the influence of pitch, roll and yaw, and five satellites are used to process 3D data (by 3rd sat), to reduce clock-

derived error (by 4th sat), and to calculate n in the initial stage (by 5th sat).

If GPS signal is blocked by a tall building or the vessel is under a bridge, the 3-axis vibrating-gyro rate sensors in the processor unit take the place of the satellite until all five satellites are in view. The rate sensors also contribute to regulating the heading data against pitch, roll and yaw together with the third antenna (A3 in the illustration).

*Ambiguity " n " is resolved by LAMBDA algorithm developed by Prof. Teussen, Delft University of Technology, The Netherlands.

The SC-110 is an enhanced satellite compass that uses Furuno's advanced GPS technology. This satellite compass can be used for a wide range of applications that require a heading signal, such as Radar/ARPA, AIS, ECDIS, Scanning Sonar, Echo Sounders, Autopilots, etc. The SC-110 utilizes a GPS carrier frequency to determine heading and the performance is not affected by ship's speed, latitude, geomagnetism, etc. Settling time is nearly instantaneous and the follow-up performance is excellent, achieving 45°/s (SOLAS HSC Code requires 20°/s as a minimum).

The SC-110 delivers GPS positioning, SOG (Speed Over Ground), COG (Course Over Ground), and ROT (Rate of Turn). SOG is remarkably accurate through decoding the Doppler shift in the received satellite signals. The information can be output through up to 11 ports in IEC61162. The heading information is output in IEC61162-2 format at the high rate of 38.4 kbps to satisfy the high speed data-output required in special applications.

Precision roll and pitch data is output in both analog and digital formats to external equipment. For sonar and echo sounders, the SC-110 offers stable echo pictures by compensating the transmitted/received beams even in rough seas. Thus, the SC-110 can also function as a highly accurate motion sensor.

The SC-110 has a unique Set and Drift mode. When connected with a water-tracking speed log, such as the DS-80, it calculates set and drift (tide direction and speed). The display helps a radar operator manually enter set and drift for accurate sea stabilization pictures.

The SC-110 consists of three GPS antennas on a solid precision support, a processor unit and a display unit. The tri-antenna system helps reduce the influence of vessels' motions more than dual-antenna systems. There are no mechanical parts such as gimbals or rotating meters, making the SC-110 free from regular costly maintenance experienced with other compasses.

Heading Mode



NAV Data Mode

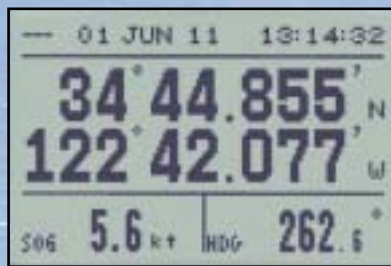

ROT Mode



Steering Mode



Set & Drift Mode



(Current (Set and Drift) and Distance Run is selectable.)

Interconnection Diagram

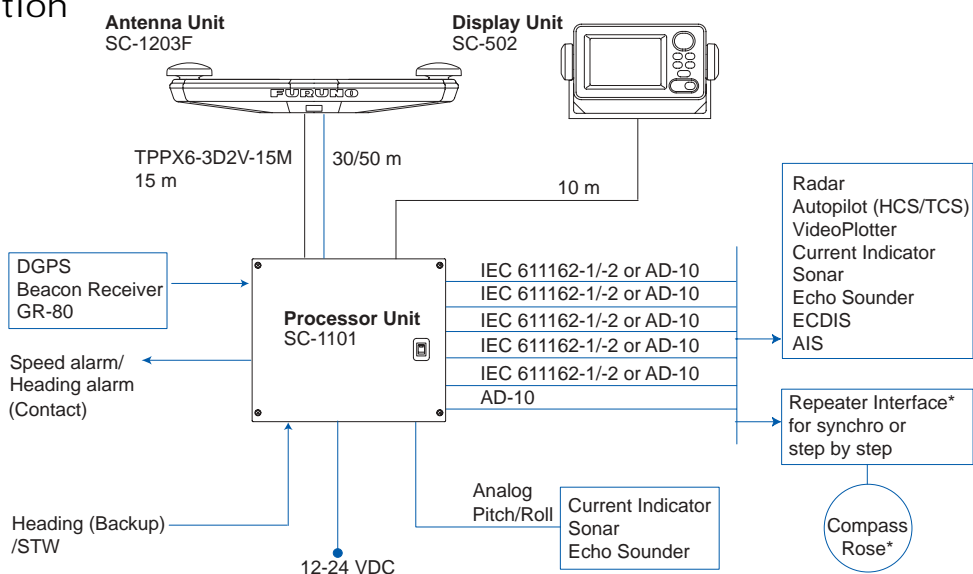

* For further info, contact our depot

SPECIFICATIONS OF SC-110

1. Accuracy

Heading: $\pm 0.6^\circ$ (95 % static accuracy)
(IMO THD MSC.116(73) static accuracy: $\pm 1.0^\circ \times \secant \text{ Lat.}$)

GPS: 10 m (95 %)

DGPS: 5 m (95 %)

2. Follow-up

45°/s rate-of-turn

3. Settling time

4 min

4. Interface

Number of ports
10 ports*

5 ports in AD-10 or
10 ports in IEC 61162-1/-2

* can be utilized in menu selection

1 port

AD-10 only

Serial data sentence

25, 100, 200 ms, 1, 2 s data rate:

HDT, HDM(Heading), ROT(Rate of turn)
ATT(Pitch and Roll)

1, 2 s data rate:

VHW(Heading), VTG, VBW(SOG),
GGA, GLL, GNS(L/L), ZDA(UTC),
VDR (Set and Drift)

Log Output

1 port: 200/400 p/nm (closure)

Alarm Output

1 port: Alarm signal (closure signal)

Heading Input

1 port: Backup Heading
(AD-10/IEC 61162-1)

DGPS Input

HDT, HDG, HDM, VBW, VHW, VLW
1 port: RTCM SC-104 format

5. Receiver Type

Twelve discrete channels.
C/A code, all-in-view

6. Receive Freq

L1 (1575.42 MHz)

7. Display Unit

Monochrome LCD, 4.5" diagonal
95 (W) x 60 (H)mm, 120 x 64 pixels

8. Display Mode

Steering, Nav Data, Compass Rose,
ROT, Heading and Set and Drift modes

POWER SUPPLY 12-24 VDC, 15 W

ENVIRONMENTAL

IEC 60945 for EMC, Vibration, Temperature

EQUIPMENT LIST

Standard

- | | |
|---|--------|
| 1. Display Unit* SC-502 | 1 unit |
| 2. Antenna Unit* SC-1203F with 15 m cable | 1 unit |
| 3. Processor Unit* SC-1101 | 1 unit |

(* Including Installation Materials and Spare Parts)

Option

- Antenna Cable 30 m CP20-01700, 50 m CP20-01710
- Flush Mount Kit S type CP20-17, F type CP20-29

Display Unit

0.55 kg 1.2 lb

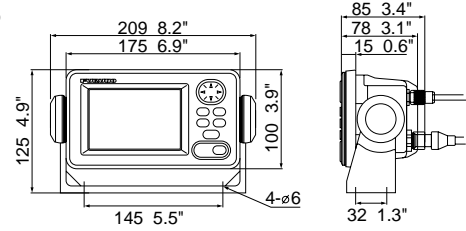

Flush Mount Kit F type

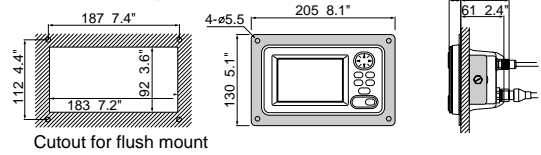

Flush Mount Kit S type

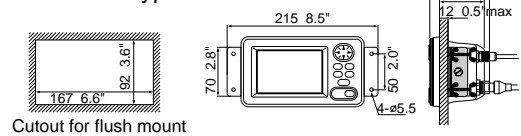

Processor Unit

4.2 kg 9.3 lb

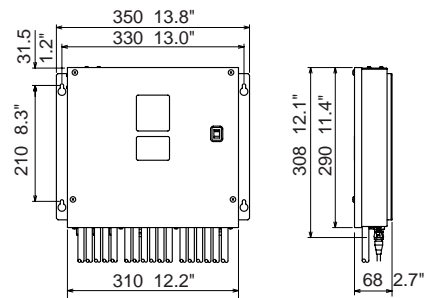

Antenna Unit

6.8 kg 15.0 lb

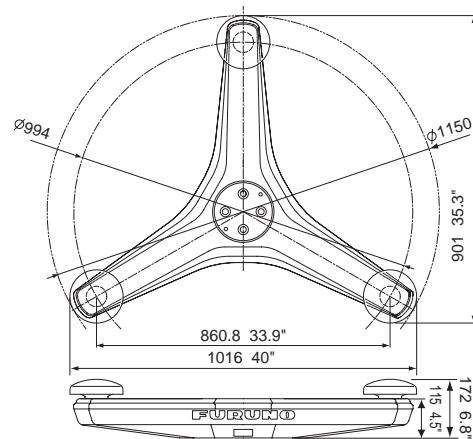

SPECIFICATIONS SUBJECT TO CHANGE WITHOUT NOTICE

FURUNO U.S.A., INC.
Camas, Washington, U.S.A.
Phone: +1 360-834-9300 Fax: +1 360-834-9400

FURUNO (UK) LIMITED
Denmead, Hampshire, U.K.
Phone: +44 2392-230303 Fax: +44 2392-230101

FURUNO FRANCE S.A.
Bordeaux-Mérignac, France
Phone: +33 5 56 13 48 00 Fax: +33 5 56 13 48 01

FURUNO ESPAÑA S.A.

FURUNO DANMARK AS
Hvidovre, Denmark
Phone: +45 36 77 45 00 Fax: +45 36 77 45 01

FURUNO NORGE A/S
Ålesund, Norway
Phone: +47 70 102950 Fax: +47 70 127021

FURUNO SVERIGE AB
Västra Frölunda, Sweden
Phone: +46 31-7098940 Fax: +46 31-497093

FURUNO FINLAND OY

04065N Printed in Japan